

Article number: 203160M16173B4W

Description: E+G levelling foot
GN 31-60-M16-173-B4-W

Note: W With adjustable sleeve , Hygienic Version, Wrench flat at the bottom

Measures

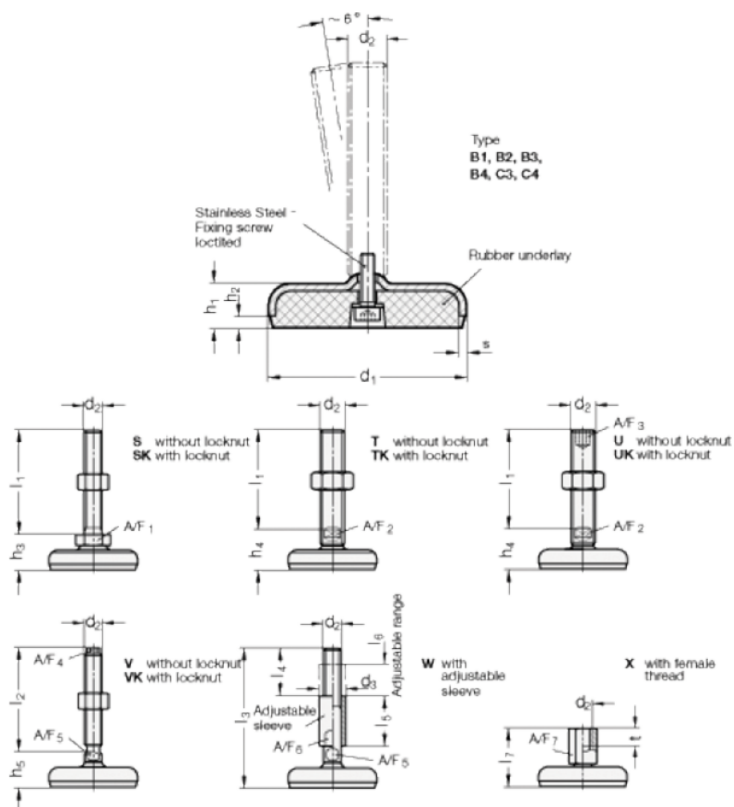

A/F5 = 12	I3 +4.0/0 = 173
A/F6 = 20	I4 = 45
d1 = 60	I5 = 45
d2 = 16	I6 = 29
d3 = 24	s = 3
h1 = 16	
h2 = 4	
I1 = 173	